

KLEIN®

Sistema de puertas correderas con detención suave
Sliding doors with soft closing system
Système de porte coulissantes avec freinage contrôlé
Schiebetürsystem mit sanftem Schließen



ROLLGLASS+

Interiorismo Vidrio
Interior Design Glass
Décoration d'Intérieur Verre
Innenarchitektur Glas



reddot award 2018
winner



ROLLGLASS+

SILVER



BRONZE



BLACK



KBS



KSC

ROLLGLASS+ 50

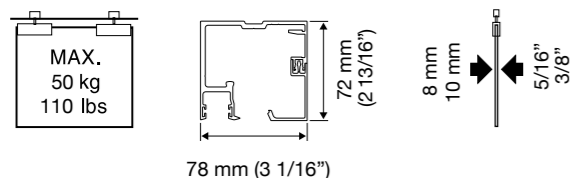

ROLLGLASS+ 100

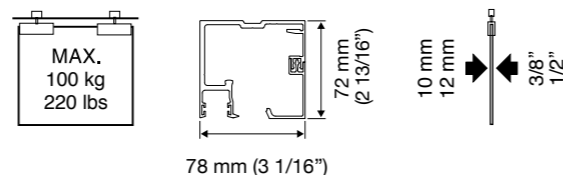

ROLLGLASS+ 150

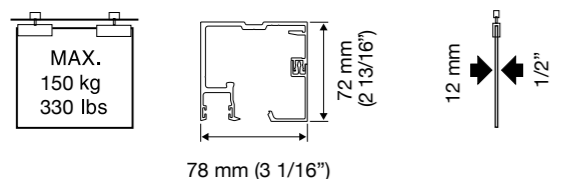

ESP

Rollglass+: crea un frente acristalado que combina paneles de vidrio fijos y móviles mediante una única guía. Puede esconderse en falso techo para un efecto absolutamente minimalista. Versátil y flexible, permite variadas combinaciones y cuida todos los detalles.

- Instalación a techo o a falso techo.
- Perfil especial para falso techo, con aletas escondidas para una máxima integración arquitectónica.
- Nueva mordaza: centraliza todas las prestaciones del sistema: regulación en altura, activación del mecanismo de frenado, y dispositivo antidescabalgamiento.
- Montaje rápido e intuitivo:
 - Acceso directo a la mordaza.
 - Sistema empotrado a falso techo: montaje en dos fases para una instalación eficiente.
 - Perfil inferior en "L" para una fácil inserción frontal del vidrio
- Diseño limpio e innovador.
- Disponible con o sin perfil inferior para el vidrio fijo.
- Vidrio de 8, 10 o 12 mm, hasta 150 Kg por hoja corredera.
- Regulación de la altura de +/- 3 mm.*
- Perfil de aluminio anodizado Silver, Negro y Bronce.
- Deslizamiento silencioso y con mínimo esfuerzo.
- Garantía KLEIN® 5 años.
- Opciones de frenado de la puerta:
 - **KSC, Klein Soft Closing:** Detención suave controlada.
 - **KBS, Klein Brake System:** Tope con freno amortiguador. De serie en toda la gama.*

Sistemas testados hasta 100.000 ciclos según la norma EN1527 por IFT Rosenheim.

FRA

Rollglass+: un seul et unique rail pour créer une cloison vitrée qui combine des panneaux fixes et coulissants. Le système peut être inséré dans le faux plafond pour un rendu absolument minimaliste. Flexible et polyvalent, il permet de multiples configurations tout en prenant soin de tous les détails.

- Installation à plafond et à faux-plafond.
- Rail spécial pour faux-plafond, avec ailettes cachées pour une absolue intégration architecturale.
- Nouvelle pince, centralisatrice de toutes les prestations du système: réglage en hauteur, activation du mécanisme de freinage, dispositif antidéraillement.
- Montage rapide et intuitif pour une mise en place efficace:
 - Accès direct à la pince de serrage.
 - Système encastré dans le faux plafond : montage en deux étapes, pour une installation plus aisée.
 - Rail inférieur en forme de "L" pour faciliter l'insertion frontale du verre.
- Design épuré et novateur.
- Disponible avec ou sans rail inférieur pour le verre fixe.
- Verre de 8, 10 ou 12 mm, jusqu'à 150 Kg par vantail coulissant.
- Réglage en hauteur de +/- 3 mm.*
- Rail en aluminium anodisé Silver, Noir ou Bronze.
- Coulisement silencieux et sans efforts.
- Garantie KLEIN® 5 ans.
- Options de freinage de la porte:
 - **KSC, Klein Soft Closing:** Freinage contrôlé, en douceur.
 - **KBS, Klein Brake System:** Butée avec frein amortisseur. Prestation standard sur toute la gamme.*

Systèmes testés jusqu'à 100.000 cycles selon la norme EN1527.

*Válido para productos ROLLGLASS+ 50 y 100 / Valid for ROLLGLASS+ 50 and 100 / Valable pour les produits ROLLGLASS+ 50 et 100 / Gültig für ROLLGLASS+ 50 und 100

ENG

Rollglass+: creates a glass front that combines fixed and mobile glass panels on a single track. It can be hidden in a drop ceiling for a completely minimalist effect. Versatile and flexible, it allows for various combinations, down to the smallest detail.

- Installation on ceiling or in drop ceiling.
- Special profile with hidden dropped ceiling wings for maximum architectural integration.
- A new clamp which centralises all features of the system: heightadjustment, activation of the braking mechanism, and anti-derailing device.
- Fast and intuitive assembly for efficient implementation:
 - Direct access to the clamp.
 - System embedded in drop ceiling: two-phase assembly for easy installation.
 - Bottom profile in a double "L" shape for easy frontal insertion of the glass.
- Clean, innovative design.
- Available with or without bottom profile for the fixed glass.
- 8, 10 or 12 mm glass, weighing up to 150 kg per sliding pane.
- Height adjustment of +/- 3 mm.*
- Silver, Black and Bronze anodized aluminum profiles.
- Silent and effortless sliding.
- Five-year KLEIN® warranty.
- Soft closing options:
 - **KSC, Klein Soft Closing:** Smooth, controlled closing.
 - **KBS, Klein Brake System:** Stop with damper brake. Standard for the entire line.*

Systems tested up to 100,000 cycles as per standard EN1527 by IFT Rosenheim.

DEU

Rollglass+: Raumteiler aus Glas, der feste Glasplatten mit beweglichen Elementen auf einer einzigen Führung kombiniert. Die Führung kann auch in einer Zwischendecke verborgen werden, so dass der Raum absolut minimalistisch wirkt. Vielseitig und flexibel. Es sind verschiedene, bis in kleinste Detail durchdachte Kombinationen möglich.

- Montage an der Decke oder in der Zwischendecke.
- Spezialprofil für Zwischendecken, mit verborgenen Flügeln für eine maximale architektonische Integration.
- Neue Führungsbacken: hier sind alle Funktionen zentralisiert: Höheneinstellung, Aktivieren des Bremsmechanismus und Aushängeschutz.
- Schnelle und intuitive Montage:
 - Direkter Zugriff auf die Führungsbacken.
 - System für den Einbau in Zwischendecke: Montage in zwei Phasen für den einfachen Einbau.
 - Unteres Profil mit der Form eines „L“ für ein einfaches Einsetzen der Glasplatte.
- Klares und innovatives Design.
- Mit oder ohne unteres Profil für das fest montierte Glas lieferbar.
- 8, 10 oder 12 mm Gläser mit einem Gewicht von bis zu 150 kg pro Türflügel der Schiebetür.
- Höheneinstellung +/- 3 mm.*
- Profil aus eloxiertem Aluminium Silver, Schwarz und Bronze.
- Geräuschloses Gleiten mit minimalem Kraftaufwand.
- Garantie von KLEIN® 5 Jahre.
- Optionen für das Bremssystem der Tür:
 - **KSC, Klein Soft Closing:** sanftes, kontrolliertes Bremsen.
 - **KBS, Klein Brake System:** Anschlag mit stoßdämpfender Bremse. Serienmäßige Ausstattung im gesamten Sortiment.*

Systeme gemäß der Norm EN1527 bis 100.000 Zyklen getestet.

Visto / Exposed / En applique / Sichtbar

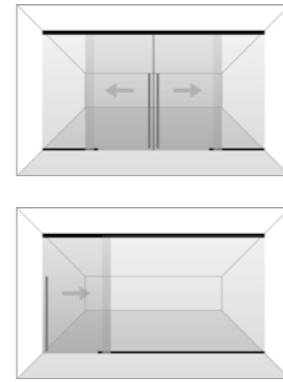
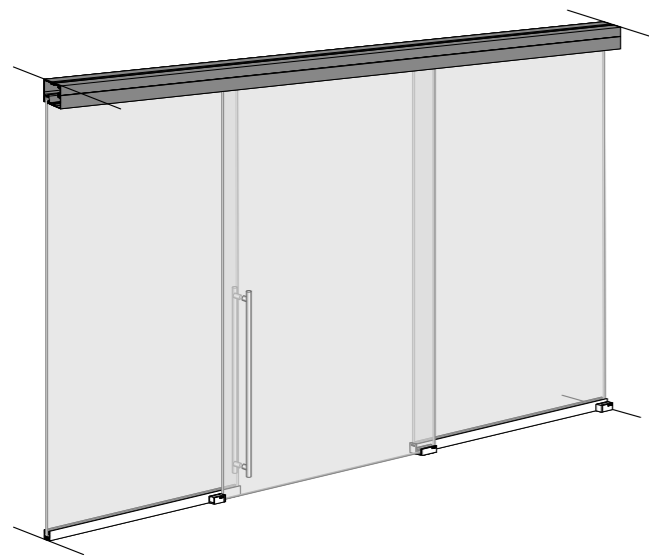

ROLLGLASS+ 50/100

ROLLGLASS+ 150

Empotrado / Recessed / Encastré / Eingebaut

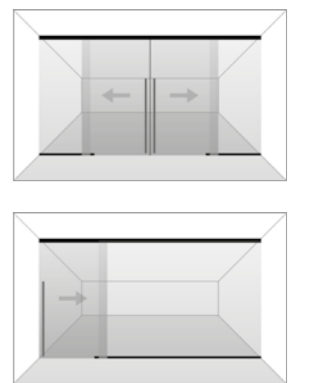
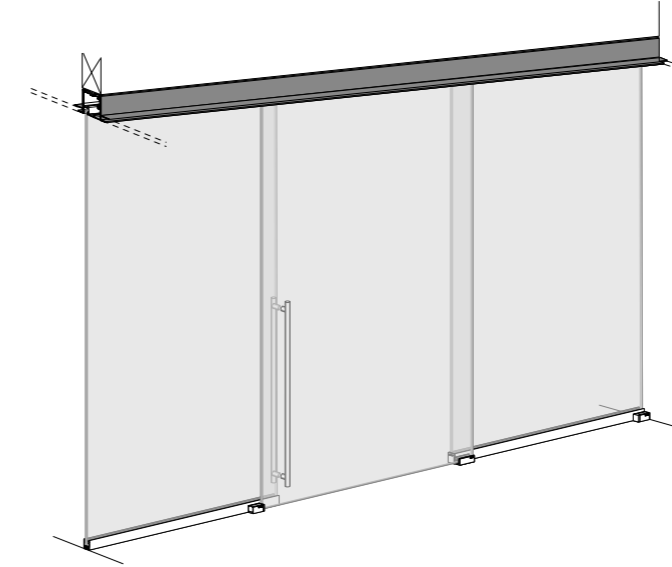

ROLLGLASS+ 50/100

ROLLGLASS+ 150

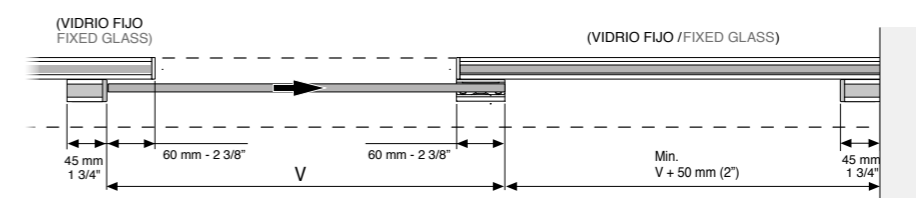
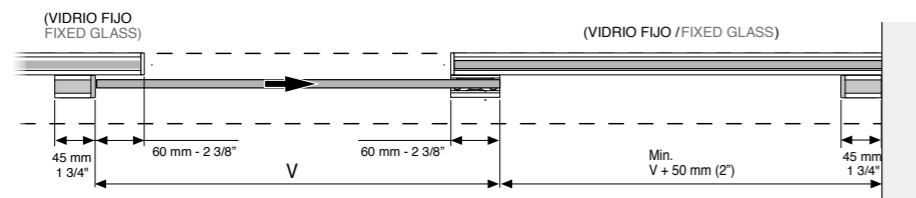
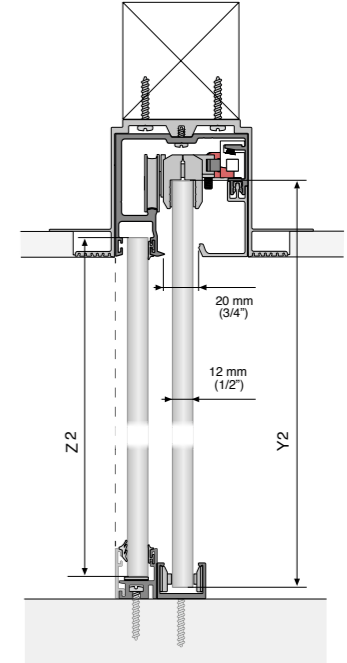
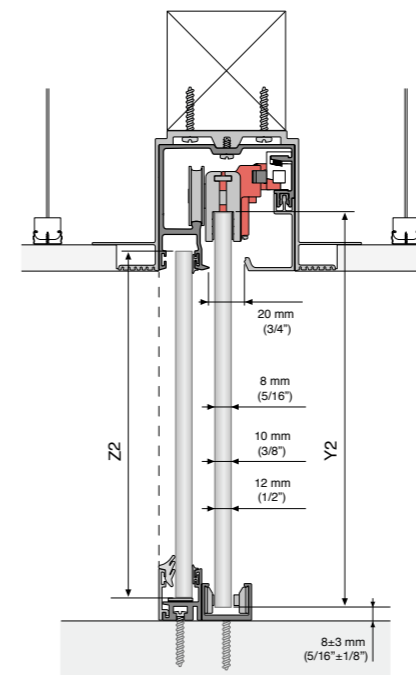
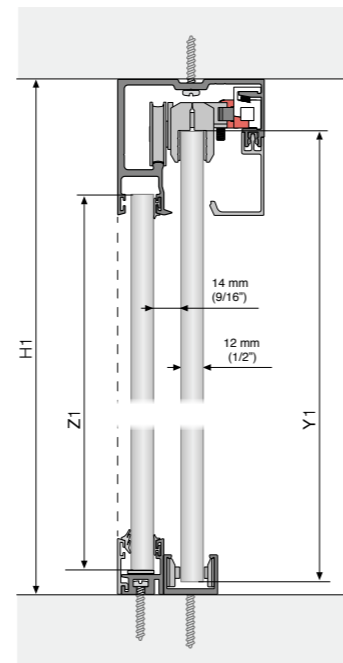
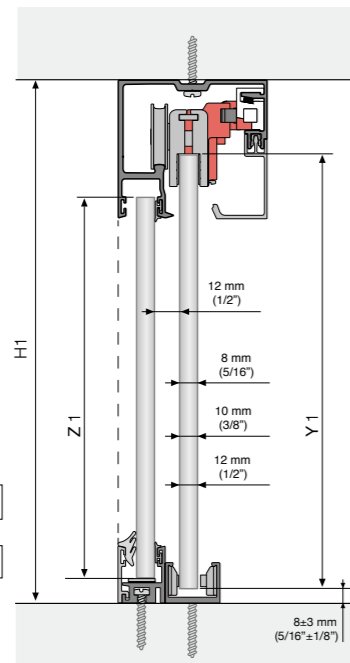

KSC ROLLGLASS+ 50/100 V ≥ 800 mm (31 1/2")
 KSC ROLLGLASS+ 150 V ≥ 1000 mm (39")

KSC ROLLGLASS+ 50/100 V ≥ 800 mm (31 1/2")
 KSC ROLLGLASS+ 150 V ≥ 1000 mm (39")

REFERENCIAS / REFERENCES / RÉFÉRENCES / REFERENZ

ESP

ROLLGLASS+ 50 SILVER			
Ref.	Descripción	U.	Img.
2402	PFS. ROLLGLASS+ 50 SILVER 2m	1	A
2403	PFS. ROLLGLASS+ 50 SILVER 3m	1	A
2404	PFS. ROLLGLASS+ 50 SILVER 4m	1	A
2406	PFS. ROLLGLASS+ 50 SILVER 6m	1	A
2401	PF. SUPERIOR ROLLGLASS+ 50 SILVER 2m	1	B
2405	PF. SUPERIOR ROLLGLASS+ 50 SILVER 3m	1	B
2407	PF. SUPERIOR ROLLGLASS+ 50 SILVER 4m	1	B
2408	PF. SUPERIOR ROLLGLASS+ 50 SILVER 6m	1	B
2300	JGO. ACC. ROLLGLASS+ 50 KSC V8-10 SILVER	1	I
2310	JGO. ACC. ROLLGLASS+ 50 KBS V8-10 SILVER	1	J
2492	PFS. FALSO TECHO ROLLGLASS+ 2m	1	C
2493	PFS. FALSO TECHO ROLLGLASS+ 3m	1	C
2494	PFS. FALSO TECHO ROLLGLASS+ 4m	1	C
2496	PFS. FALSO TECHO ROLLGLASS+ 6m	1	C

ROLLGLASS+ 100/150 SILVER			
Ref.	Descripción	U.	Img.
2412	PFS. ROLLGLASS+ 100/150 SILVER 2m	1	A
2413	PFS. ROLLGLASS+ 100/150 SILVER 3m	1	A
2414	PFS. ROLLGLASS+ 100/150 SILVER 4m	1	A
2416	PFS. ROLLGLASS+ 100/150 SILVER 6m	1	A
2411	PF. SUPERIOR ROLLGLASS+ 100/150 SILVER 2m	1	B
2415	PF. SUPERIOR ROLLGLASS+ 100/150 SILVER 3m	1	B
2417	PF. SUPERIOR ROLLGLASS+ 100/150 SILVER 4m	1	B
2418	PF. SUPERIOR ROLLGLASS+ 100/150 SILVER 6m	1	B
2350	JGO. ACC. ROLLGLASS+ 100 KSC V10-12 SILVER	1	O
2360	JGO. ACC. ROLLGLASS+ 100 KBS V10-12 SILVER	1	P
2550	JGO. ACC. ROLLGLASS+ 150 KSC V12 SILVER	1	U
2492	PFS. FALSO TECHO ROLLGLASS+ 100/150 2m	1	C
2493	PFS. FALSO TECHO ROLLGLASS+ 100/150 3m	1	C
2494	PFS. FALSO TECHO ROLLGLASS+ 100/150 4m	1	C
2496	PFS. FALSO TECHO ROLLGLASS+ 100/150 6m	1	C

ROLLGLASS+ 50 BRONCE			
Ref.	Descripción	U.	Img.
2422	PFS. ROLLGLASS+ 50 BRONCE 2m	1	D
2423	PFS. ROLLGLASS+ 50 BRONCE 3m	1	D
2424	PFS. ROLLGLASS+ 50 BRONCE 4m	1	D
2426	PFS. ROLLGLASS+ 50 BRONCE 6m	1	D
2421	PF. SUPERIOR ROLLGLASS+ 50 BRONCE 2m	1	E
2425	PF. SUPERIOR ROLLGLASS+ 50 BRONCE 3m	1	E
2427	PF. SUPERIOR ROLLGLASS+ 50 BRONCE 4m	1	E
2428	PF. SUPERIOR ROLLGLASS+ 50 BRONCE 6m	1	E
2320	JGO. ACC. ROLLGLASS+ 50 KSC V8-10 BRONCE	1	K
2340	JGO. ACC. ROLLGLASS+ 50 KBS V8-10 BRONCE	1	L

ROLLGLASS+ 100/150 BRONCE			
Ref.	Descripción	U.	Img.
2442	PFS. ROLLGLASS+ 100/150 BRONCE 2m	1	D
2443	PFS. ROLLGLASS+ 100/150 BRONCE 3m	1	D
2444	PFS. ROLLGLASS+ 100/150 BRONCE 4m	1	D
2446	PFS. ROLLGLASS+ 100/150 BRONCE 6m	1	D
2441	PF. SUPERIOR ROLLGLASS+ 100/150 BRONCE 2m	1	E
2445	PF. SUPERIOR ROLLGLASS+ 100/150 BRONCE 3m	1	E
2447	PF. SUPERIOR ROLLGLASS+ 100/150 BRONCE 4m	1	E
2448	PF. SUPERIOR ROLLGLASS+ 100/150 BRONCE 6m	1	E
2380	JGO. ACC. ROLLGLASS+ 100 KSC V10-12 BRONCE	1	Q
2381	JGO. ACC. ROLLGLASS+ 100 KBS V10-12 BRONCE	1	R
2580	JGO. ACC. ROLLGLASS+ 150 KSC V12 BRONCE	1	V

ROLLGLASS+ 50 NEGRO			
Ref.	Descripción	U.	Img.
2432	PFS. ROLLGLASS+ 50 NEGRO 2m	1	F
2433	PFS. ROLLGLASS+ 50 NEGRO 3m	1	F
2434	PFS. ROLLGLASS+ 50 NEGRO 4m	1	F
2436	PFS. ROLLGLASS+ 50 NEGRO 6m	1	F
2431	PF. SUPERIOR ROLLGLASS+ 50 NEGRO 2m	1	G
2435	PF. SUPERIOR ROLLGLASS+ 50 NEGRO 3m	1	G
2437	PF. SUPERIOR ROLLGLASS+ 50 NEGRO 4m	1	G
2438	PF. SUPERIOR ROLLGLASS+ 50 NEGRO 6m	1	G
2330	JGO. ACC. ROLLGLASS+ 50 KSC V8-10 NEGRO	1	M
2370	JGO. ACC. ROLLGLASS+ 50 KBS V8-10 NEGRO	1	N

ROLLGLASS+ 100/150 NEGRO			
Ref.	Descripción	U.	Img.
2452	PFS. ROLLGLASS+ 100/150 NEGRO 2m	1	F
2453	PFS. ROLLGLASS+ 100/150 NEGRO 3m	1	F
2454	PFS. ROLLGLASS+ 100/150 NEGRO 4m	1	F
2456	PFS. ROLLGLASS+ 100/150 NEGRO 6m	1	F
2451	PF. SUPERIOR ROLLGLASS+ 100/150 NEGRO 2m	1	G
2455	PF. SUPERIOR ROLLGLASS+ 100/150 NEGRO 3m	1	G
2457	PF. SUPERIOR ROLLGLASS+ 100/150 NEGRO 4m	1	G
2458	PF. SUPERIOR ROLLGLASS+ 100/150 NEGRO 6m	1	G
2390	JGO. ACC. ROLLGLASS+ 100 KSC V10-12 NEGRO	1	S
2391	JGO. ACC. ROLLGLASS+ 100 KBS V10-12 NEGRO	1	T
2590	JGO. ACC. ROLLGLASS+ 150 KSC V12 NEGRO	1	W

ENG

ROLLGLASS+ 50 SILVER			
Ref.	Description	Units	Img.
2402	PFS. ROLLGLASS+ 50 SILVER 2m	1	A
2403	PFS. ROLLGLASS+ 50 SILVER 3m	1	A
2404	PFS. ROLLGLASS+ 50 SILVER 4m	1	A
2406	PFS. ROLLGLASS+ 50 SILVER 6m	1	A
2401	UPPER PF. ROLLGLASS+ 50 SILVER 2m	1	B
2405	UPPER PF. ROLLGLASS+ 50 SILVER 3m	1	B
2407	UPPER PF. ROLLGLASS+ 50 SILVER 4m	1	B
2408	UPPER PF. ROLLGLASS+ 50 SILVER 6m	1	B
2300	SET OF ACC. ROLLGLASS+ 50 KSC V8-10 SILVER	1	I
2310	SET OF ACC. ROLLGLASS+ 50 KBS V8-10 SILVER	1	J
2492	RECESSED PF. ROLLGLASS+ 2m	1	C
2493	RECESSED PF. ROLLGLASS+ 3m	1	C
2494	RECESSED PF. ROLLGLASS+ 4m	1	C
2496	RECESSED PF. ROLLGLASS+ 6m	1	C

ROLLGLASS+ 100/150 SILVER			
Ref.	Description	Units	Img.
2412	PFS. ROLLGLASS+ 100/150 SILVER 2m	1	A
2413	PFS. ROLLGLASS+ 100/150 SILVER 3m	1	A
2414	PFS. ROLLGLASS+ 100/150 SILVER 4m	1	A
2416	PFS. ROLLGLASS+ 100/150 SILVER 6m	1	A
2411	UPPER PF. ROLLGLASS+ 100/150 SILVER 2m	1	B
2415	UPPER PF. ROLLGLASS+ 100/150 SILVER 3m	1	B
2417	UPPER PF. ROLLGLASS+ 100/150 SILVER 4m	1	B
2418	UPPER PF. ROLLGLASS+ 100/150 SILVER 6m	1	B
2350	SET OF ACC. ROLLGLASS+ 100 KSC V10-12 SILVER	1	O
2360	SET OF ACC. ROLLGLASS+ 100 KBS V10-12 SILVER	1	P
2550	SET OF ACC. ROLLGLASS+ 150 KSC V12 SILVER	1	U
2492	RECESSED PF. ROLLGLASS+ 100/150 2m	1	C
2493	RECESSED PF. ROLLGLASS+ 100/150 3m	1	C
2494	RECESSED PF. ROLLGLASS+ 100/150 4m	1	C
2496	RECESSED PF. ROLLGLASS+ 100/150 6m	1	C

ROLLGLASS+ 50 BRONZE			
Ref.	Description	Units	Img.
2422	PFS. ROLLGLASS+ 50 BRONZE 2m	1	D
2423	PFS. ROLLGLASS+ 50 BRONZE 3m	1	D
2424	PFS. ROLLGLASS+ 50 BRONZE 4m	1	D
2426	PFS. ROLLGLASS+ 50 BRONZE 6m	1	D
2421	UPPER PF. ROLLGLASS+ 50 BRONZE 2m	1	E
2425	UPPER PF. ROLLGLASS+ 50 BRONZE 3m	1	E
2427	UPPER PF. ROLLGLASS+ 50 BRONZE 4m	1	E
2428	UPPER PF. ROLLGLASS+ 50 BRONZE 6m	1	E
2320	SET OF ACC. ROLLGLASS+ 50 KSC V8-10 BRONZE	1	K
2340	SET OF ACC. ROLLGLASS+ 50 KBS V8-10 BRONZE	1	L

ROLLGLASS+ 100/150 BRONZE			
Ref.	Description	Units	Img.
2442	PFS. ROLLGLASS+ 100/150 BRONZE 2m	1	D
2443	PFS. ROLLGLASS+ 100/150 BRONZE 3m	1	D
2444	PFS. ROLLGLASS+ 100/150 BRONZE 4m	1	D
2446	PFS. ROLLGLASS+ 100/150 BRONZE 6m	1	D
2441	UPPER PF. ROLLGLASS+ 100/150 BRONZE 2m	1	E
2445	UPPER PF. ROLLGLASS+ 100/150 BRONZE 3m	1	E
2447	UPPER PF. ROLLGLASS+ 100/150 BRONZE 4m	1	E
2448	UPPER PF. ROLLGLASS+ 100/150 BRONZE 6m	1	E
2380	SET OF ACC. ROLLGLASS+ 100 KSC V10-12 BRONZE	1	Q
2381	SET OF ACC. ROLLGLASS+ 100 KBS V10-12 BRONZE	1	R
2580	SET OF ACC. ROLLGLASS+ 150 KSC V12 BRONZE	1	V

ROLLGLASS+ 50 BLACK			
Ref.	Description	Units	Img.
2432	PFS. ROLLGLASS+ 50 BLACK 2m	1	F
2433	PFS. ROLLGLASS+ 50 BLACK 3m	1	F
2434	PFS. ROLLGLASS+ 50 BLACK 4m	1	F
2436	PFS. ROLLGLASS+ 50 BLACK 6m	1	F
2431	UPPER PF. ROLLGLASS+ 50 BLACK 2m	1	G
2435	UPPER PF. ROLLGLASS+ 50 BLACK 3m	1	G
2437	UPPER PF. ROLLGLASS+ 50 BLACK 4m	1	G
2438	UPPER PF. ROLLGLASS+ 50 BLACK 6m	1	G
2330	SET OF ACC. ROLLGLASS+ 50 KSC V8-10 BLACK	1	M
2370	SET OF ACC. ROLLGLASS+ 50 KBS V8-10 BLACK	1	N

ROLLGLASS+ 100/150 BLACK			
Ref.	Description	Units	Img.
2452	PFS. ROLLGLASS+ 100/150 BLACK 2m	1	F
2453	PFS. ROLLGLASS+ 100/150 BLACK 3m	1	F
2454	PFS. ROLLGLASS+ 100/150 BLACK 4m	1	F
2456	PFS. ROLLGLASS+ 100/150 BLACK 6m	1	F
2451	UPPER PF. ROLLGLASS+ 100/150 BLACK 2m	1	G
2455	UPPER PF. ROLLGLASS+ 100/150 BLACK 3m	1	G
2457	UPPER PF. ROLLGLASS+ 100/150 BLACK 4m	1	G
2458	UPPER PF. ROLLGLASS+ 100/150 BLACK 6m	1	G
2390	SET OF ACC. ROLLGLASS+ 100 KSC V10-12 BLACK	1	S
2391	SET OF ACC. ROLLGLASS+ 100 KBS V10-12 BLACK	1	T
2590	SET OF ACC. ROLLGLASS+ 150 KSC V12 BLACK	1	W

REFERENCIAS / REFERENCES / RÉFÉRENCES / REFERENZ

FRA

ROLLGLASS+ 50 SILVER			
Ref.	Description	Unités	Img.
2402	RAILS ROLLGLASS+ 50 SILVER 2m	1	A
2403	RAILS ROLLGLASS+ 50 SILVER 3m	1	A
2404	RAILS ROLLGLASS+ 50 SILVER 4m	1	A
2406	RAILS ROLLGLASS+ 50 SILVER 6m	1	A
2401	RAIL SUPÉRIEUR ROLLGLASS+ 50 SILVER 2m	1	B
2405	RAIL SUPÉRIEUR ROLLGLASS+ 50 SILVER 3m	1	B
2407	RAIL SUPÉRIEUR ROLLGLASS+ 50 SILVER 4m	1	B
2408	RAIL SUPÉRIEUR ROLLGLASS+ 50 SILVER 6m	1	B
2300	JEU ACC. ROLLGLASS+ 50 KSC V8-10 SILVER	1	I
2310	JEU ACC. ROLLGLASS+ 50 KBS V8-10 SILVER	1	J
2492	RAIL FAUX PLAFOND ROLLGLASS+ 2m	1	C
2493	RAIL FAUX PLAFOND ROLLGLASS+ 3m	1	C
2494	RAIL FAUX PLAFOND ROLLGLASS+ 4m	1	C
2496	RAIL FAUX PLAFOND ROLLGLASS+ 6m	1	C

ROLLGLASS+ 100/150 SILVER			
Ref.	Description	Unités	Img.
2412	RAILS ROLLGLASS+ 100/150 SILVER 2m	1	A
2413	RAILS ROLLGLASS+ 100/150 SILVER 3m	1	A
2414	RAILS ROLLGLASS+ 100/150 SILVER 4m	1	A
2416	RAILS ROLLGLASS+ 100/150 SILVER 6m	1	A
2411	RAIL SUPÉRIEUR ROLLGLASS+ 100/150 SILVER 2m	1	B
2415	RAIL SUPÉRIEUR ROLLGLASS+ 100/150 SILVER 3m	1	B
2417	RAIL SUPÉRIEUR ROLLGLASS+ 100/150 SILVER 4m	1	B
2418	RAIL SUPÉRIEUR ROLLGLASS+ 100/150 SILVER 6m	1	B
2350	JEU ACC. ROLLGLASS+ 100 KSC V10-12 SILVER	1	O
2360	JEU ACC. ROLLGLASS+ 100 KBS V10-12 SILVER	1	P
2550	JEU ACC. ROLLGLASS+ 150 KSC V12 SILVER	1	U
2492	RAIL FAUX PLAFOND ROLLGLASS+ 100/150 2m	1	C
2493	RAIL FAUX PLAFOND ROLLGLASS+ 100/150 3m	1	C
2494	RAIL FAUX PLAFOND ROLLGLASS+ 100/150 4m	1	C
2496	RAIL FAUX PLAFOND ROLLGLASS+ 100/150 6m	1	C

ROLLGLASS+ 50 BRONZE			
Ref.	Description	Unités	Img.
2422	RAILS ROLLGLASS+ 50 BRONZE 2m	1	D
2423	RAILS ROLLGLASS+ 50 BRONZE 3m	1	D
2424	RAILS ROLLGLASS+ 50 BRONZE 4m	1	D
2426	RAILS ROLLGLASS+ 50 BRONZE 6m	1	D
2421	RAIL SUPÉRIEUR ROLLGLASS+ 50 BRONZE 2m	1	E
2425	RAIL SUPÉRIEUR ROLLGLASS+ 50 BRONZE 3m	1	E
2427	RAIL SUPÉRIEUR ROLLGLASS+ 50 BRONZE 4m	1	E
2428	RAIL SUPÉRIEUR ROLLGLASS+ 50 BRONZE 6m	1	E
2320	JEU ACC. ROLLGLASS+ 50 KSC V8-10 BRONZE	1	K
2340	JEU ACC. ROLLGLASS+ 50 KBS V8-10 BRONZE	1	L

ROLLGLASS+ 100/150 BRONZE			
Ref.	Description	Unités	Img.
2442	RAILS ROLLGLASS+ 100/150 BRONZE 2m	1	D
2443	RAILS ROLLGLASS+ 100/150 BRONZE 3m	1	D
2444	RAILS ROLLGLASS+ 100/150 BRONZE 4m	1	D
2446	RAILS ROLLGLASS+ 100/150 BRONZE 6m	1	D
2441	RAIL SUPÉRIEUR ROLLGLASS+ 100/150 BRONZE 2m	1	E
2445	RAIL SUPÉRIEUR ROLLGLASS+ 100/150 BRONZE 3m	1	E
2447	RAIL SUPÉRIEUR ROLLGLASS+ 100/150 BRONZE 4m	1	E
2448	RAIL SUPÉRIEUR ROLLGLASS+ 100/150 BRONZE 6m	1	E
2380	JEU ACC. ROLLGLASS+ 100 KSC V10-12 BRONZE	1	Q
2381	JEU ACC. ROLLGLASS+ 100 KBS V10-12 BRONZE	1	R
2580	JEU ACC. ROLLGLASS+ 150 KSC V12 BRONZE	1	V

ROLLGLASS+ 50 NOIR			
Ref.	Description	Unités	Img.
2432	RAILS ROLLGLASS+ 50 NOIR 2m	1	F
2433	RAILS ROLLGLASS+ 50 NOIR 3m	1	F
2434	RAILS ROLLGLASS+ 50 NOIR 4m	1	F
2436	RAILS ROLLGLASS+ 50 NOIR 6m	1	F
2431	RAIL SUPÉRIEUR ROLLGLASS+ 50 NOIR 2m	1	G
2435	RAIL SUPÉRIEUR ROLLGLASS+ 50 NOIR 3m	1	G
2437	RAIL SUPÉRIEUR ROLLGLASS+ 50 NOIR 4m	1	G
2438	RAIL SUPÉRIEUR ROLLGLASS+ 50 NOIR 6m	1	G
2330	JEU ACC. ROLLGLASS+ 50 KSC V8-10 NOIR	1	M
2370	JEU ACC. ROLLGLASS+ 50 KBS V8-10 NOIR	1	N

ROLLGLASS+ 100/150 NOIR			
Ref.	Description	Unités	Img.
2452	RAILS ROLLGLASS+ 100/150 NOIR 2m	1	F
2453	RAILS ROLLGLASS+ 100/150 NOIR 3m	1	F
2454	RAILS ROLLGLASS+ 100/150 NOIR 4m	1	F
2456	RAILS ROLLGLASS+ 100/150 NOIR 6m	1	F
2451	RAIL SUPÉRIEUR ROLLGLASS+ 100/150 NOIR 2m	1	G
2455	RAIL SUPÉRIEUR ROLLGLASS+ 100/150 NOIR 3m	1	G
2457	RAIL SUPÉRIEUR ROLLGLASS+ 100/150 NOIR 4m	1	G
2458	RAIL SUPÉRIEUR ROLLGLASS+ 100/150 NOIR 6m	1	G
2390	JEU ACC. ROLLGLASS+ 100 KSC V10-12 NOIR	1	S
2391	JEU ACC. ROLLGLASS+ 100 KBS V10-12 NOIR	1	T
2590	JEU ACC. ROLLGLASS+ 150 KSC V12 NOIR	1	W

DEU

ROLLGLASS+ 50 SILVER			
Ref.	Beschreibung	Einh.	Img.
2402	PFS. ROLLGLASS+ 50 SILVER 2 m	1	A
2403	PFS. ROLLGLASS+ 50 SILVER 3 m	1	A
2404	PFS. ROLLGLASS+ 50 SILVER 4 m	1	A
2406	PFS. ROLLGLASS+ 50 SILVER 6 m	1	A
2401	PF. SUPERIOR ROLLGLASS+ 50 SILVER 2 m	1	B
2405	PF. SUPERIOR ROLLGLASS+ 50 SILVER 3 m	1	B
2407	PF. SUPERIOR ROLLGLASS+ 50 SILVER 4 m	1	B
2408	PF. SUPERIOR ROLLGLASS+ 50 SILVER 6 m	1	B
2300	SET ACC. ROLLGLASS+ 50 KSC V8-10 SILVER	1	I
2310	SET ACC. ROLLGLASS+ 50 KBS V8-10 SILVER	1	J
2492	PFS. ZWISCHENDECKE ROLLGLASS+ 2 m	1	C
2493	PFS. ZWISCHENDECKE ROLLGLASS+ 3 m	1	C
2494	PFS. ZWISCHENDECKE ROLLGLASS+ 4 m	1	C
2496	PFS. ZWISCHENDECKE ROLLGLASS+ 6 m	1	C

ROLLGLASS+ 100/150 SILVER			
Ref.	Beschreibung	Einh.	Img.
2412	PFS. ROLLGLASS+ 100/150 SILVER 2 m	1	A
2413	PFS. ROLLGLASS+ 100/150 SILVER 3 m	1	A
2414	PFS. ROLLGLASS+ 100/150 SILVER 4 m	1	A
2416	PFS. ROLLGLASS+ 100/150 SILVER 6 m	1	A
2411	PF. SUPERIOR ROLLGLASS+ 100/150 SILVER 2 m	1	B
2415	PF. SUPERIOR ROLLGLASS+ 100/150 SILVER 3 m	1	B
2417	PF. SUPERIOR ROLLGLASS+ 100/150 SILVER 4 m	1	B
2418	PF. SUPERIOR ROLLGLASS+ 100/150 SILVER 6 m	1	B
2350	SET ACC. ROLLGLASS+ 100 KSC V10-12 SILVER	1	O
2360	SET ACC. ROLLGLASS+ 100 KBS V10-12 SILVER	1	P
2550	SET ACC. ROLLGLASS+ 150 KSC V12 SILVER	1	U
2492	PFS. ZWISCHENDECKE ROLLGLASS+ 100/150 2 m	1	C
2493	PFS. ZWISCHENDECKE ROLLGLASS+ 100/150 3 m	1	C
2494	PFS. ZWISCHENDECKE ROLLGLASS+ 100/150 4 m	1	C
2496	PFS. ZWISCHENDECKE ROLLGLASS+ 100/150 6 m	1	C

ROLLGLASS+ 50 BRONZE			
Ref.	Beschreibung	Einh.	Img.
2422	PFS. ROLLGLASS+ 50 BRONZE 2 m	1	D
2423	PFS. ROLLGLASS+ 50 BRONZE 3 m	1	D
2424	PFS. ROLLGLASS+ 50 BRONZE 4 m	1	D
2426	PFS. ROLLGLASS+ 50 BRONZE 6m	1	D
2421	PF. SUPERIOR ROLLGLASS+ 50 BRONZE 2 m	1	E
2425	PF. SUPERIOR ROLLGLASS+ 50 BRONZE 3 m	1	E
2427	PF. SUPERIOR ROLLGLASS+ 50 BRONZE 4 m	1	E
2428	PF. SUPERIOR ROLLGLASS+ 50 BRONZE 6 m	1	E
2320	SET ACC. ROLLGLASS+ 50 KSC V8-10 BRONZE	1	K
2340	SET ACC. ROLLGLASS+ 50 KBS V8-10 BRONZE	1	L

ROLLGLASS+ 100/150 BRONZE			
Ref.	Beschreibung	Einh.	Img.
2442	PFS. ROLLGLASS+ 100/150 BRONZE 2 m	1	D
2443	PFS. ROLLGLASS+ 100/150 BRONZE 3 m	1	D
2444	PFS. ROLLGLASS+ 100/150 BRONZE 4 m	1	D
2446	PFS. ROLLGLASS+ 100/150 BRONZE 6 m	1	D
2441	PF. SUPERIOR ROLLGLASS+ 100/150 BRONZE 2 m	1	E
2445	PF. SUPERIOR ROLLGLASS+ 100/150 BRONZE 3 m	1	E
2447	PF. SUPERIOR ROLLGLASS+ 100/150 BRONZE 4 m	1	E
2448	PF. SUPERIOR ROLLGLASS+ 100/150 BRONZE 6 m	1	E
2380	SET ACC. ROLLGLASS+ 100 KSC V10-12 BRONZE	1	Q
2381	SET ACC. ROLLGLASS+ 100 KBS V10-12 BRONZE	1	R
2580	SET ACC. ROLLGLASS+ 150 KSC V12 BRONZE	1	V

ROLLGLASS+ 50 SCHWARZ			
Ref.	Beschreibung	Einh.	Img.
2432	PFS. ROLLGLASS+ 50 SCHWARZ 2 m	1	F
2433	PFS. ROLLGLASS+ 50 SCHWARZ 3 m	1	F
2434	PFS. ROLLGLASS+ 50 SCHWARZ 4 m	1	F
2436	PFS. ROLLGLASS+ 50 SCHWARZ 6 m	1	F
2431	PF. SUPERIOR ROLLGLASS+ 50 SCHWARZ 2 m	1	G
2435	PF. SUPERIOR ROLLGLASS+ 50 SCHWARZ 3 m	1	G
2437	PF. SUPERIOR ROLLGLASS+ 50 SCHWARZ 4 m	1	G
2438	PF. SUPERIOR ROLLGLASS+ 50 SCHWARZ 6 m	1	G
2330	SET ACC. ROLLGLASS+ 50 KSC V8-10 SCHWARZ	1	M
2370	SET ACC. ROLLGLASS+ 50 KBS V8-10 SCHWARZ	1	N

ROLLGLASS+ 100/150 SCHWARZ			
Ref.	Beschreibung	Einh.	Img.
2452	PFS. ROLLGLASS+ 100/150 SCHWARZ 2 m	1	F
2453	PFS. ROLLGLASS+ 100/150 SCHWARZ 3 m	1	F
2454	PFS. ROLLGLASS+ 100/150 SCHWARZ 4 m	1	F
2456	PFS. ROLLGLASS+ 100/150 SCHWARZ 6 m	1	F
2451	PF. SUPERIOR ROLLGLASS+ 100/150 SCHWARZ 2 m	1	G
2455	PF. SUPERIOR ROLLGLASS+ 100/150 SCHWARZ 3 m	1	G
2457	PF. SUPERIOR ROLLGLASS+ 100/150 SCHWARZ 4 m	1	G
2458	PF. SUPERIOR ROLLGLASS+ 100/150 SCHWARZ 6 m	1	G
2390	SET ACC. ROLLGLASS+ 100 KSC V10-12 SCHWARZ	1	S
2391	SET ACC. ROLLGLASS+ 100 KBS V10-12 SCHWARZ	1	T
2590	SET ACC. ROLLGLASS+ 150 KSC V12 SCHWARZ	1	W

REFERENCIAS / REFERENCES / RÉFÉRENCES / REFERENZ



A



B

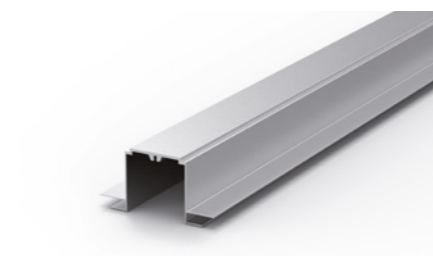

C

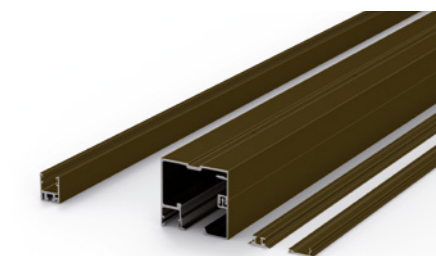

D

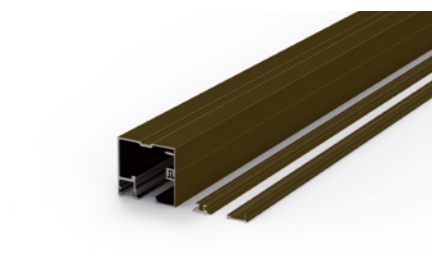

E

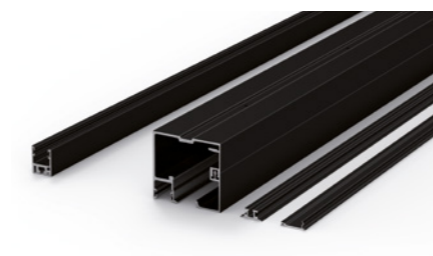

F



G

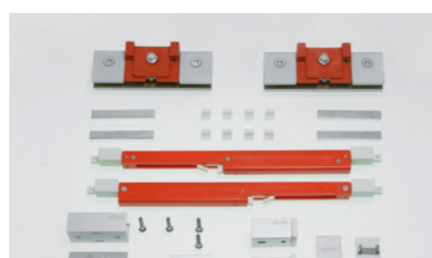

H



I

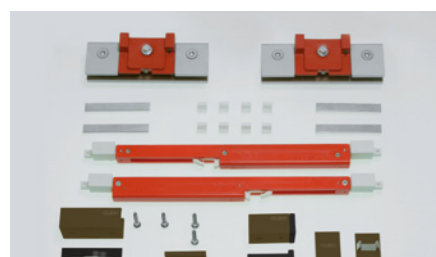

J



K

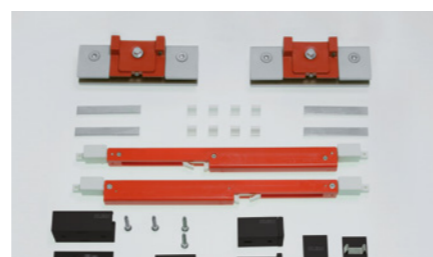

L

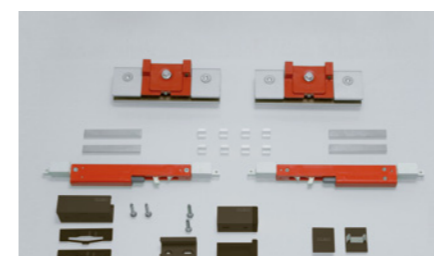

M



N

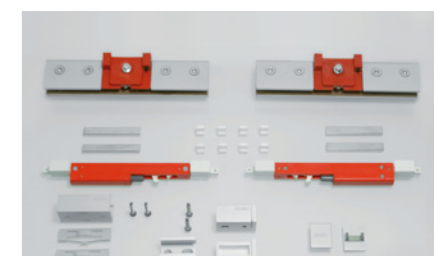

O

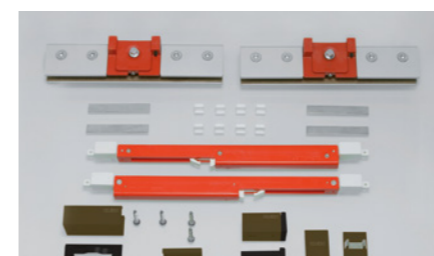

P

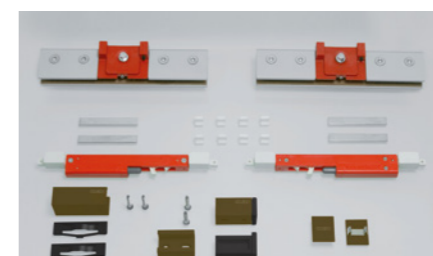

Q



R



S

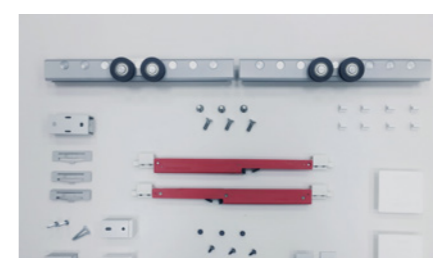

T



U

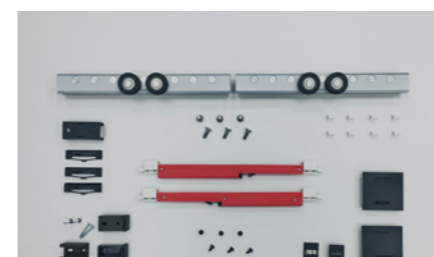

V



MEDIDAS DE LA PERFILERIA / PROFILE'S DIMENSION / DIMENSIONS DES RAILS / MASSE DER PROFILE

A	Longitud del perfil superior / Upper profile length / Longueur du rail supérieur / Länge oberes Profil
1	A - 0,5 mts
2	A / 2

KLEIN®

KLEIN EUROPE
Edificio KLEIN
Polígono Industrial Can Cuyás
N-150 Km. 1
08110 Montcada i Reixac
Barcelona (Spain)

Tel.: +34 935 760 101
Fax: +34 935 760 109

+Info
klein@klein.es
www.klein.es

Síguenos en redes
Follow us on social media

